

SCHEDA INSTALLAZIONE | INSTALLATION SHEET

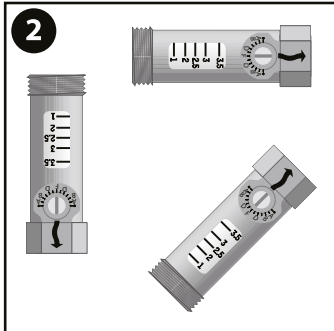

DN	G x G	L (mm)	
15	3/4" x 3/4"	80.5	24

TB	100°C	
PB	10 bar	

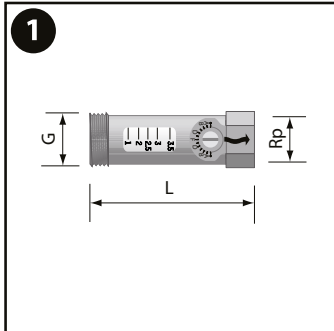

Ø 3/4" - Kv 1.8
Cod.
704554

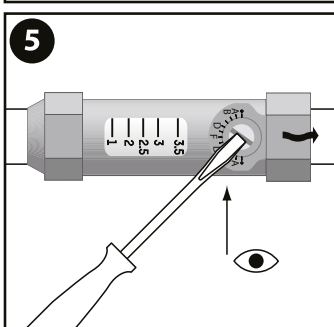
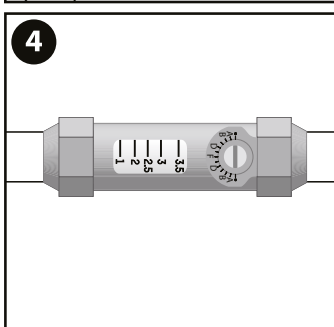
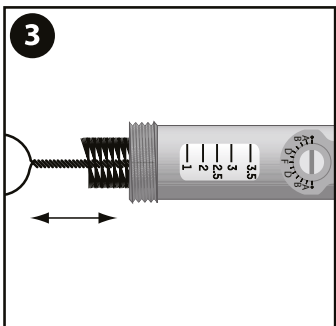
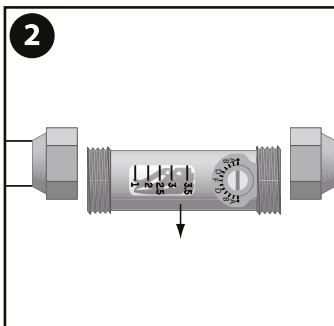
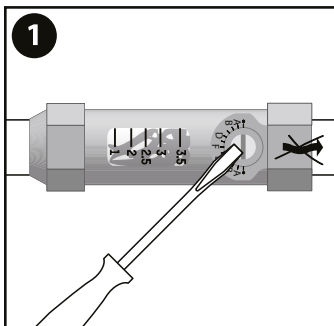
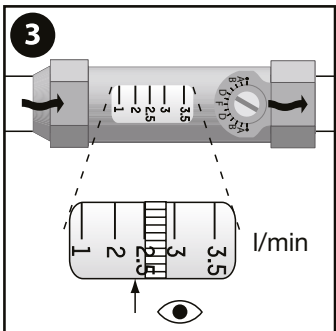
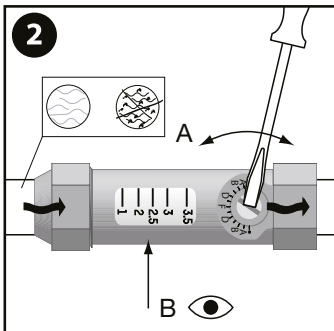
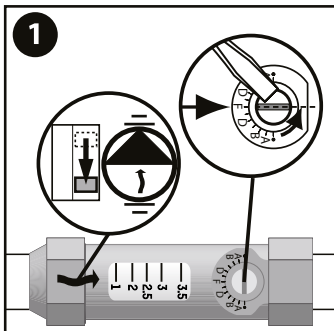
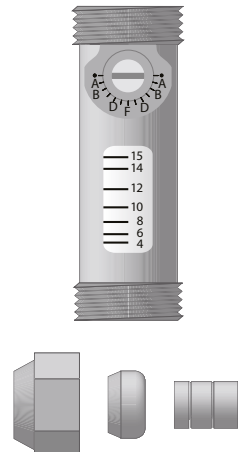
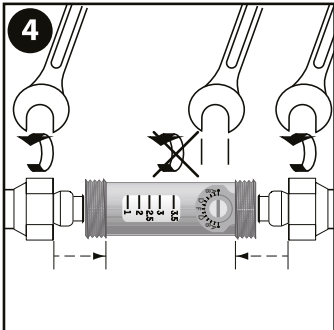
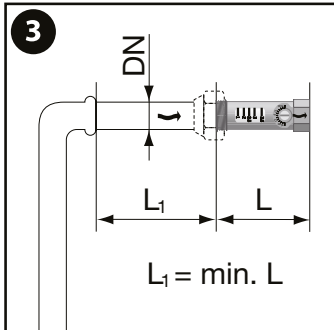

SCHEDA INSTALLAZIONE | INSTALLATION SHEET

SMALTIMENTO



Non disperdere nell'ambiente. Per lo smaltimento degli imballaggi fare sempre riferimento alle leggi locali che recepiscono le Direttive 2018/851/UE e 2018/852/UE. In Italia riferirsi ai D.Lgs 152/2006 "Testo Unico in materia Ambientale" (T.U.A.) Art. 219, comma 5 riformato dal D.Lgs 116/2020. Verificare con le autorità locali le modalità di raccolta differenziata in vigore attenendosi alle normative vigenti. Tramite il QR-Code del prodotto è possibile visualizzare la guida sulla etichettatura imballaggi per la corretta gestione dei rifiuti.

DISPOSAL



Do not dispose of in the environment. For the disposal of packaging always refer to the local laws implementing Directives 2018/851/EU and 2018/852/EU. In Italy refer to D.Lgs 152/2006 "Testo Unico in materia Ambientale" (T.U.A.) Art. 219, comma 5 reformed by D.Lgs 116/2020. Check with the local authorities on the waste collection methods in force by following the regulations in force. Via the QR-Code of the product you can view the guide on packaging labelling for correct waste management.

